

TA7233P

T-74-05-01

TENTATIVE

DUAL AUDIO POWER AMPLIFIER.

The TA7233P is a dual audio power amplifier for consumer applications.

It is suitable for power amplifier of portable stereo radio cassette and stereo receiver.

. High Power:

$$P_{OUT(1)} = 4.5W(\text{Typ.})/\text{CH}$$

$$(V_{CC} = 12V, f = 1\text{kHz}, \text{THD} = 10\%, R_L = 4\Omega)$$

$$P_{OUT(2)} = 2.5W(\text{Typ.})/\text{CH}$$

$$(V_{CC} = 9V, f = 1\text{kHz}, \text{THD} = 10\%, R_L = 4\Omega)$$

. Low Supply Current

$$: I_{CCQ} = 35\text{mA}(\text{Typ.}) \quad (V_{CC} = 12V, V_{in} = 0)$$

. Thermal Shut Down Protector

. Audio Muting Function

. Operating Supply Voltage : $V_{CC(\text{opr})} = 6 \sim 12V$

Unit in mm

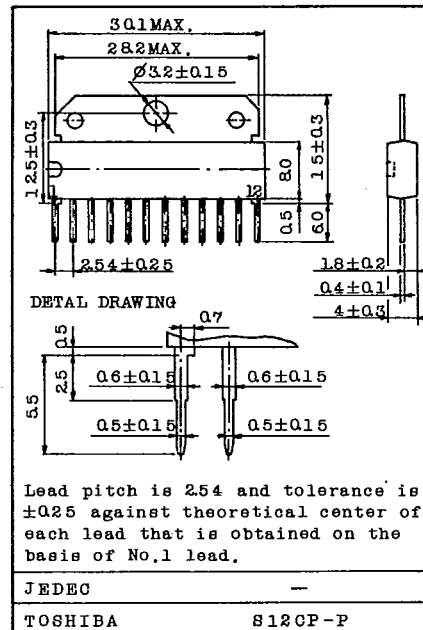
MAXIMUM RATINGS ($T_a = 25^\circ\text{C}$)

CHARACTERISTIC	SYMBOL	RATING	UNIT
Supply Voltage	V_{CC}	16	V
Output Current (Peak/CH)	$I_O(\text{peak})$	2.5	A
Power Dissipation	P_D	12.5	W
Operating Temperature	T_{opr}	-20 ~ 75	$^\circ\text{C}$
Storage Temperature	T_{stg}	-55 ~ 150	$^\circ\text{C}$

AUDIO LINEAR IC

9097247 TOSHIBA. ELECTRONIC

02E 16935 D

TA7233P

T-74-05-01

ELECTRICAL CHARACTERISTICS

(Unless otherwise specified, $V_{CC}=12V$, $R_L=4\Omega$, $R_g=600\Omega$, $f=1kHz$, $T_a=25^\circ C$)

CHARACTERISTIC	SYMBOL	TEST CIR-CUIT	TEST CONDITION	MIN.	TYP.	MAX.	UNIT
Quiescent Current	I_{CCQ}		$V_{in}=0$	-	35	60	mA
Output Power	$P_{OUT(1)}$		THD=10%	3.8	4.5	-	W
	$P_{OUT(2)}$		THD=10%, $V_{CC}=9V$	2.0	2.5	-	
Total Harmonic Distortion	THD		$P_{OUT}=1W/CH.$	-	0.1	0.8	%
Voltage Gain	$G_V(1)$		$R_f=150\Omega$ $V_{OUT}=0.775V_{rms}$	43	45	47	dB
	$G_V(2)$		$R_f=0$, $V_{OUT}=0.775V_{rms}$	-	57	-	
Input Resistance	R_{IN}		-	-	30	-	$k\Omega$
Output Noise Voltage	V_{NO}		$R_g=10k\Omega$ $BW=20Hz \sim 20kHz$	-	0.4	0.7	mV_{rms}
Ripple Rejection Ratio	R.R.		$R_g=600\Omega$ $f_{ripple}=100Hz$	-	45	-	dB
Cross Talk	CT		$R_g=10k\Omega$, $Ampl \leftrightarrow 2$ $V_{OUT}=0dBm$, $f=1kHz$	-	60	-	dB
Input Offset Voltage	V_5, V_7		-	-	35	60	mV

TYPICAL DC VOLTAGE OF EACH TERMINAL

 $(V_{CC}=12V, T_a=25^\circ C)$

TERMINAL No.	1	2	3	4	5	6	7	8	9	10	11	12
DC Voltage (V)	11.5	6	6.7	0.7	0.035	GND	0.035	0.7	GND	6	11.5	V_{CC}

TOSHIBA

TA7233P

T-74-05-01

BLOCK DIAGRAM, TEST CIRCUIT

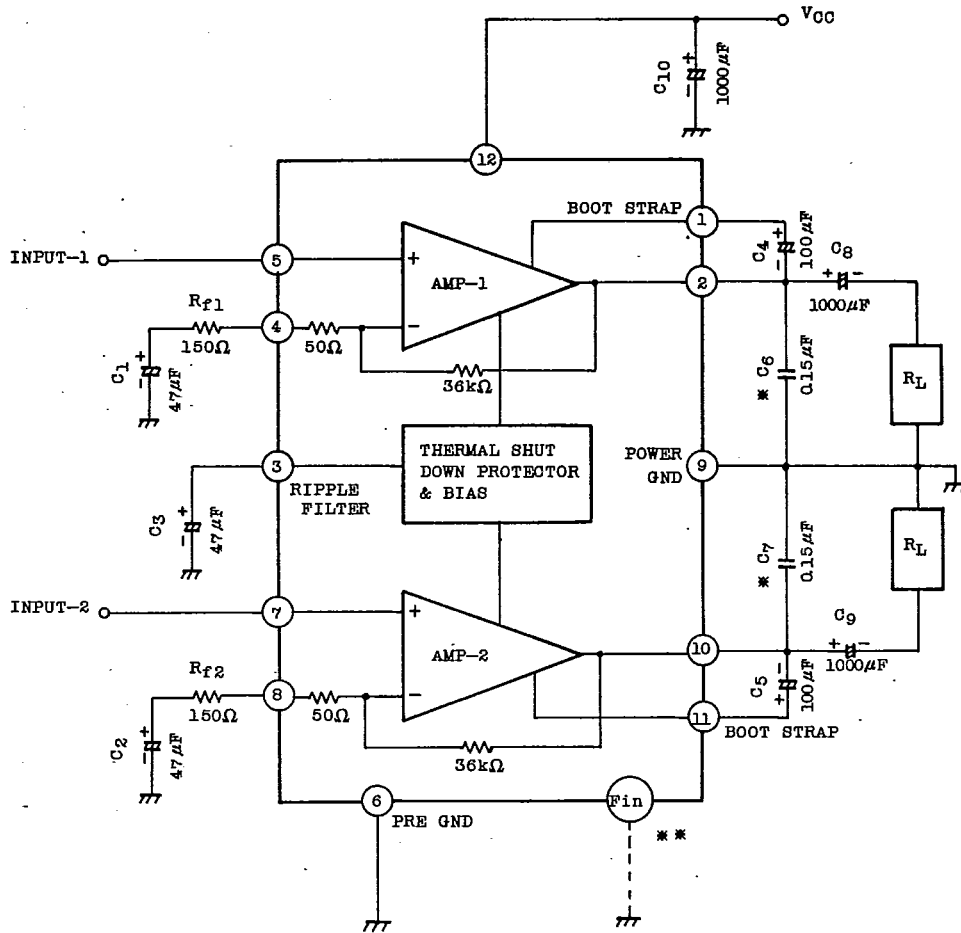

* C₆, C₇ : Polystyroll capacitor

** Heat Sink (Fin) : Connect to GND or open

AUDIO LINEAR IC

TA7233P

T-74-05-01

APPLICATION INFORMATION

1. VOLTAGE GAIN ADJUSTMENT

The voltage gain : G_v is determined by R_1 , R_2 and R_f .

$$G_v = 20 \log \frac{R_f + R_1 + R_2}{R_f + R_1}$$

When $R_f = 0$

$$G_v = 57 \text{dB (Typ.)}$$

When $R_f = 150 \Omega$

$$G_v = 45 \text{dB (Typ.) is given.}$$

The recommended voltage gain is more than 40dB.

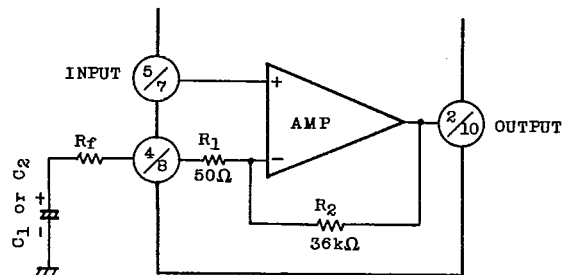

Fig. 1

2. AUDIO MUTING

Audio muting can be accomplished by connecting 3 pin (ripple filter) to GND as shown in Fig.2.

Then, the bias circuit are cut off.

Amount of muting attenuation is about 60dB.

The ripple filter : C_3 is in dead states at muting on. Therefore, the ripple rejection ratio should be checked at muting on/off in applications.

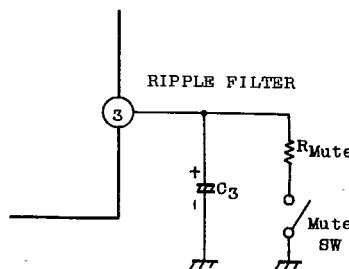

Fig. 2

TA7233P

T-74-05-01

3. INPUT AMPLIFIER

The first stage is a PNP transistor, the input terminal voltage (Q_1 base) is 60mV and less, and the volume : V_R can be directly coupled without a coupling capacitor.

But volume slide noise should be checked at volume up/down in applications.

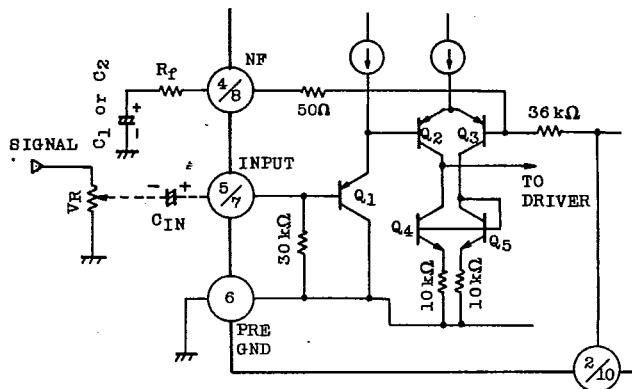

Fig. 3

4. THERMAL SHUT DOWN CIRCUIT

This IC built in thermal shut down protector.

The operating temperature of thermal shut down circuit is 160°C (Typ.)

5. CAPACITOR C_6 , C_7

The purpose of capacitor C_6 , C_7 are to prevent oscillation.

These capacitors need to be small temperature coefficient.

So celamic capacitor is unsuitable.

The voltage gain less than 40dB results occasionally in a parastic oscillation.

The following capacitor layout is recommended to refer the standard print board.

6. INPUT VOLTAGE

The maximum input voltage is 300mV_{rms}(typ.). (at $V_{CC}=12V$, $R_L=4\Omega$, $f=1kHz$)

When input voltage is more 300mV_{rms}, the output wave is turn up.

TA7233P

STANDARD PRINT PATTERN

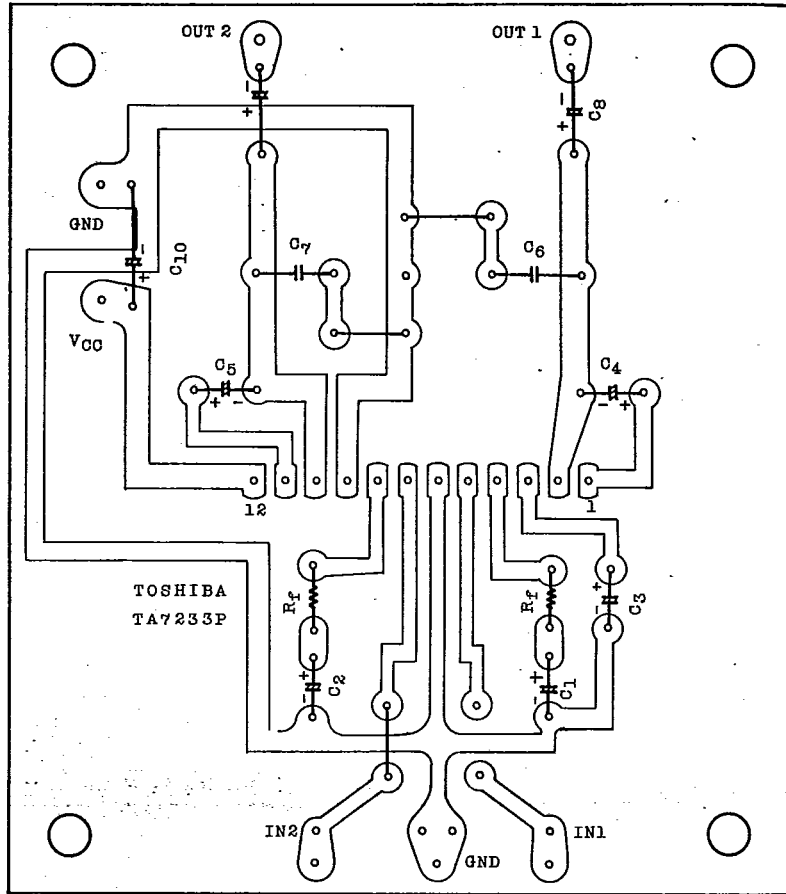

TA7233P

T-74-05-01

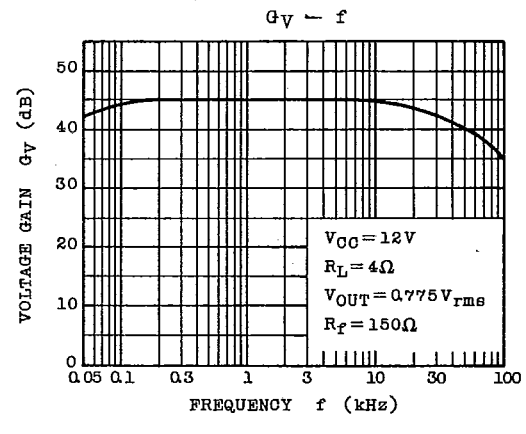
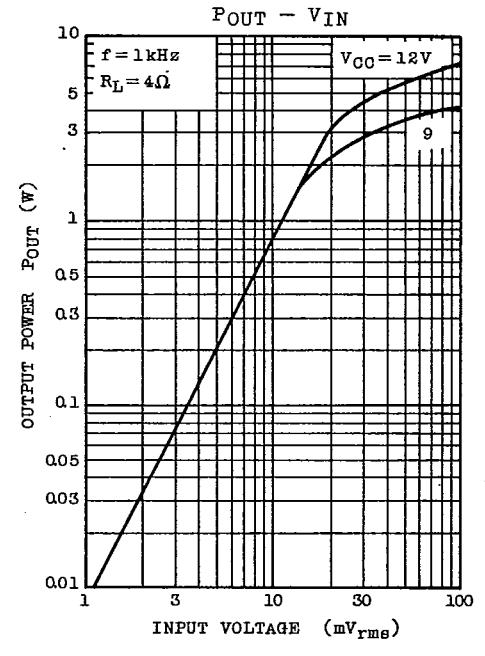
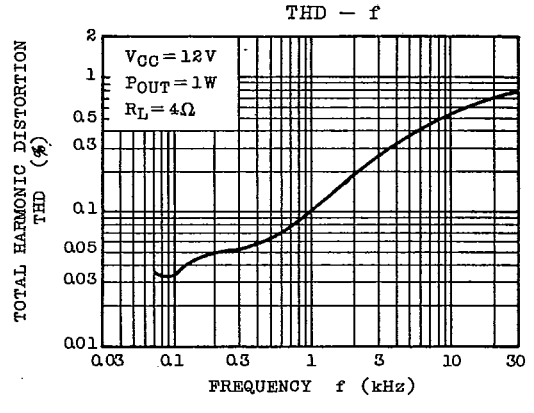
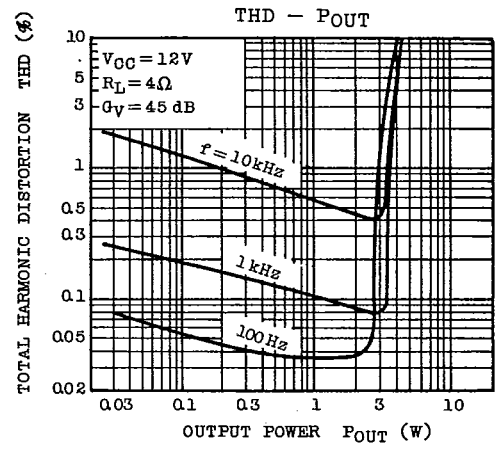
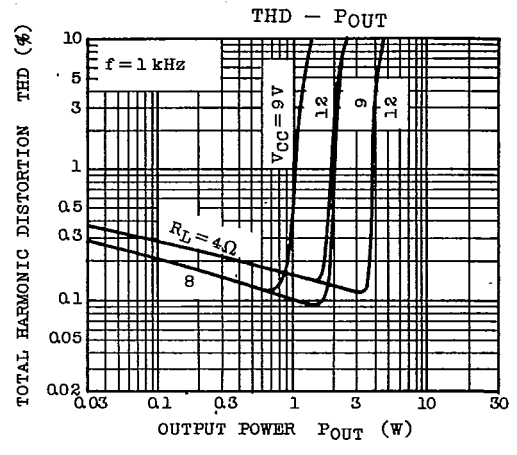

AUDIO LINEAR IC

TA7233P

T-74-05-01

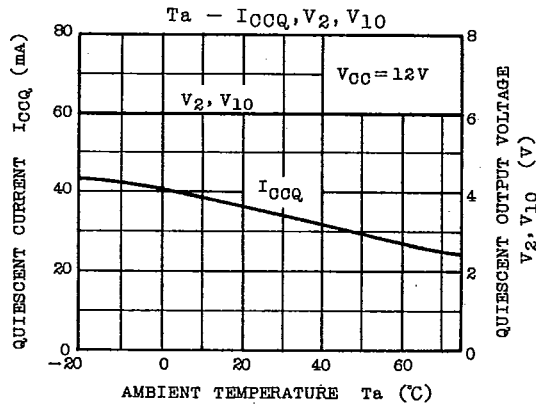
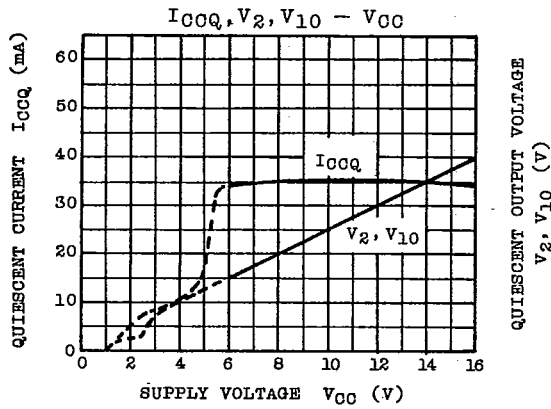
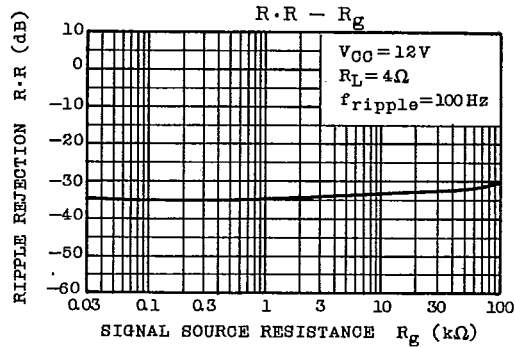
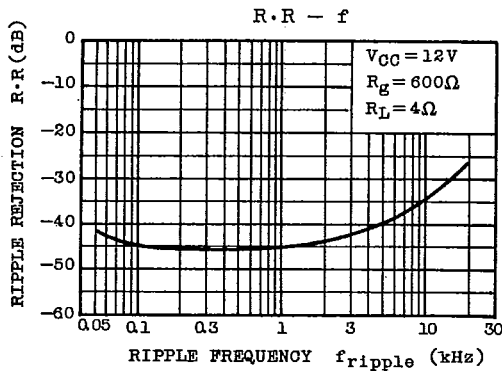
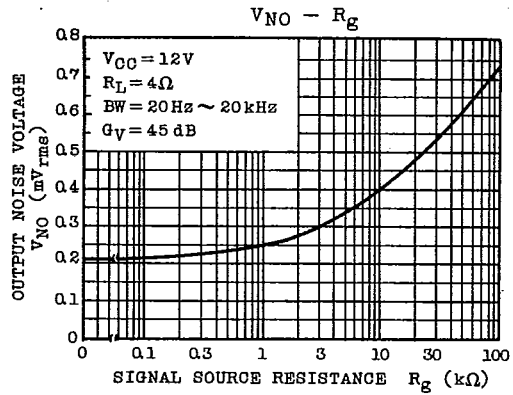
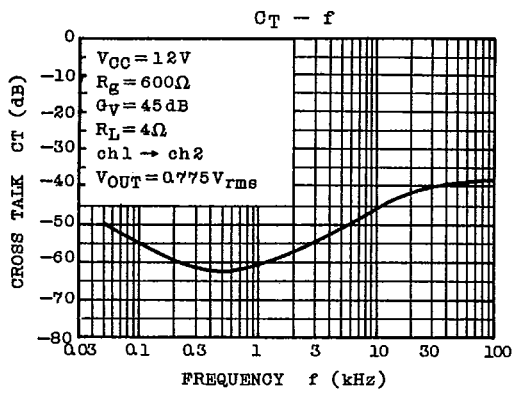

TA7233P

T-74-05-01

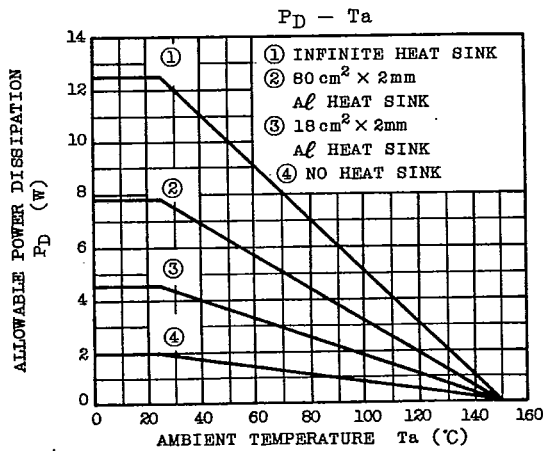
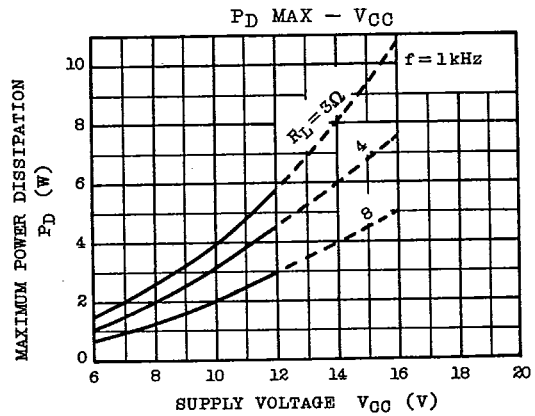
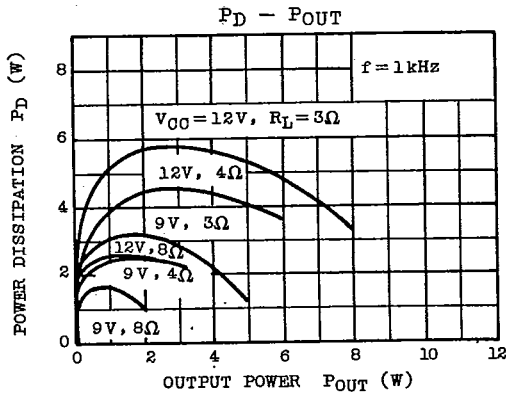
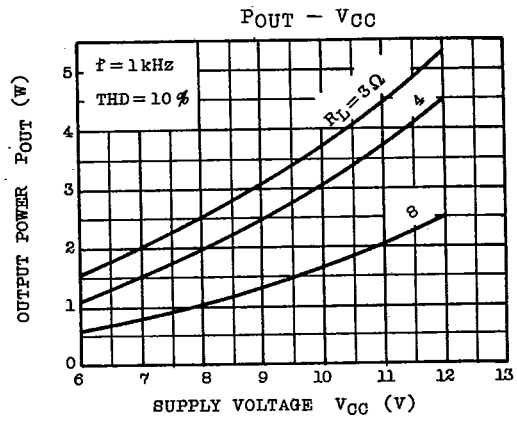
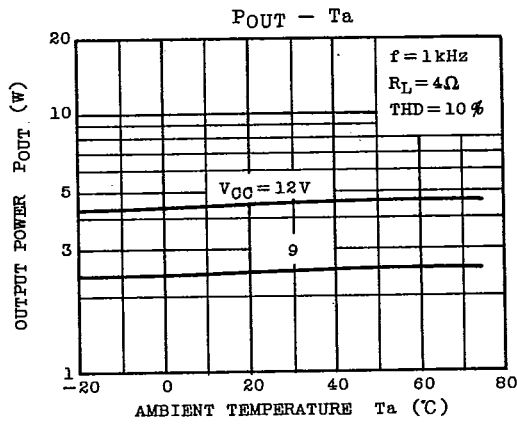

AUDIO LINEAR IC